



RF360  
Europe GmbH

## Data sheet

### BAW filter

5.7 GHz Wi-Fi 6 UNII2c-4

Part number:	B8378
Ordering code:	B39572B8378L210
Date:	June 13, 2023
Version:	2.7

DCN: 80-PA243-729 Rev. B

Qualcomm products mentioned herein are products of Qualcomm Technologies, Inc. and/or its subsidiaries.

RF360 Europe GmbH  
Anzinger Straße 13  
81671 Munich, Germany

© 2023 Qualcomm Technologies, Inc. and/or its subsidiaries. All rights reserved

These materials, including the information contained herein, may be used only for informational purposes by the customer. Qualcomm Technologies, Inc. and/or its subsidiaries assume no responsibility for errors or omissions in these materials or the information contained herein and reserve the right to make changes to the product(s) or information contained herein without notice. The materials and information are provided on an AS IS basis, without warranty, either expressed or implied, with respect to the materials, or any output or results based on the use, application, or evaluation of such materials, including without limitation, with respect to the non-infringement of trademarks, patents, copyrights or any other intellectual property rights or other rights of third parties.

No use of this documentation or any information contained herein grants any license, whether express, implied, by estoppel or otherwise, to any intellectual property rights, including, without limitation, to any patents owned by QUALCOMM Incorporated or any of its subsidiaries.

Not to be used, copied, reproduced, or modified in whole or in part, nor its contents revealed in any manner to others without the express written permission of RF360 Europe GmbH.

Qualcomm is a trademark or registered trademark of Qualcomm Incorporated. Other product and brand names may be trademarks or registered trademarks of their respective owners.

This technical data may be subject to U.S. and international export, re-export, or transfer ("export") laws. Diversion contrary to U.S. and international law is strictly prohibited.

**Table of contents**

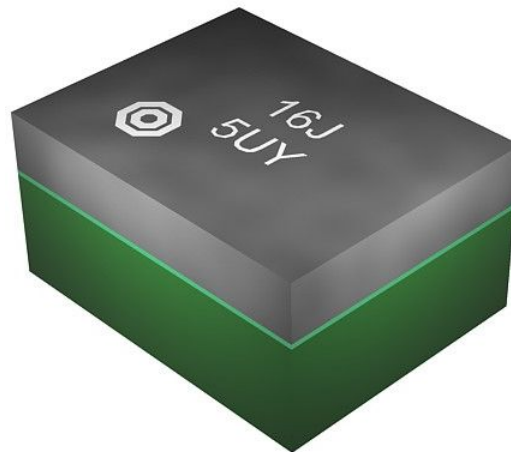
1 [Application](#)..... 4  
2 [Features](#)..... 4  
3 [Package](#)..... 5  
4 [Pin configuration](#)..... 5  
5 [Matching circuit](#)..... 6  
6 [Characteristics](#)..... 7  
7 [Maximum ratings](#)..... 8  
8 [Transmission coefficient](#)..... 9  
9 [Transmission coefficient \(WLAN\)](#)..... 10  
10 [Reflection coefficients](#)..... 11  
11 [Packing material](#)..... 12  
12 [Marking](#)..... 15  
13 [Soldering profile](#)..... 16  
14 [Annotations](#)..... 17  
15 [Cautions and warnings](#)..... 18  
16 [ESD protection of acoustic devices](#)..... 19  
17 [Important notes](#)..... 20

## 1 Application

- Low-loss BAW RF coexistence filter for 5.7 GHz Wi-Fi 6 UNII2c-4
- 5.7 GHz Wi-Fi 6 UNII2c-4: pass band 5490 – 5895 MHz
- Usable pass band : 405 MHz

## 2 Features

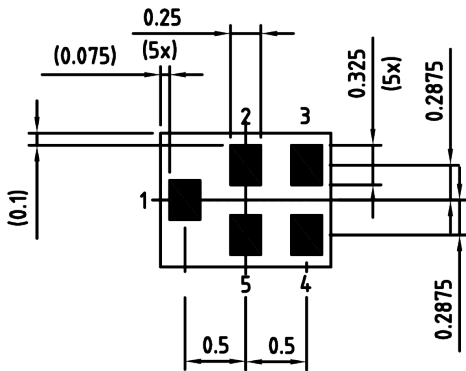
- Package size  $1.4_{\pm 0.05}$  mm  $\times$   $1.1_{\pm 0.05}$  mm
- Package height 0.63 mm (max.)
- Approximate weight 2 mg
- RoHS compatible
- Package for Surface Mount Technology (SMT)
- Ni/Au-plated terminals
- Electrostatic Sensitive Device (ESD)
- Moisture Sensitivity Level 3 (MSL3)



**Figure 1:** Picture of component with example of product marking.

3 Package

BOTTOM VIEW

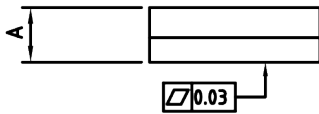


Pad and pitch tolerance  $\pm 0.05$

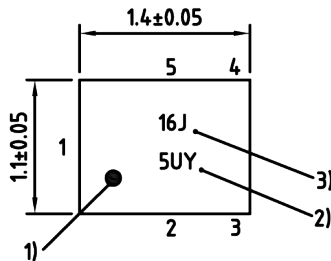
4 Pin configuration

- 1 Input
- 4 Output
- 2, 3, 5 Ground

SIDE VIEW

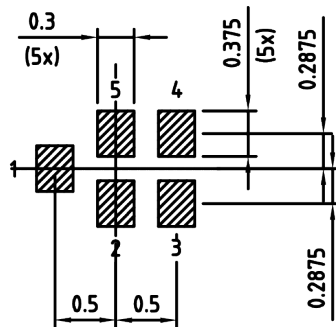


TOP VIEW



- 1) Marking for pad number 1
- 2) Example of encoded lot number
- 3) Example of encoded filter type number

Land pattern  
THRU VIEW



Landing pad tolerance  $-0.02$

**Figure 2:** Drawing of package with package height A = 0.63 mm (max.). See Sec. Package information (p. 18).

5 Matching circuit

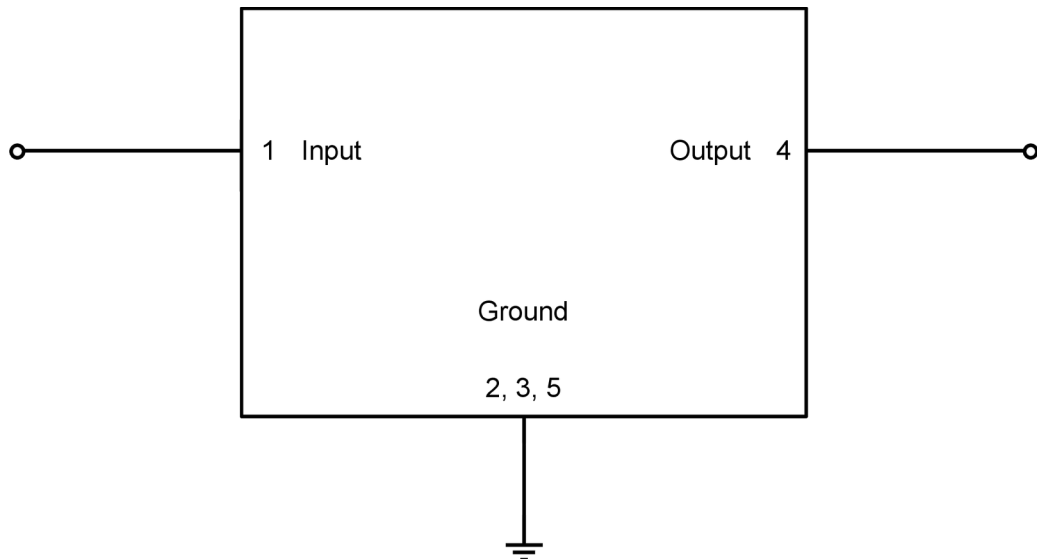


Figure 3: Schematic of matching circuit. No external matching components required.

## 6 Characteristics

Temperature range for specification	$T_{SPEC}$	= -30 °C ... +85 °C
Input terminating impedance	$Z_{IN}$	= 50 $\Omega$
Output terminating impedance	$Z_{OUT}$	= 50 $\Omega$

Characteristics			min. for $T_{SPEC}$	typ. @ +25 °C	max. for $T_{SPEC}$	
<b>Maximum insertion attenuation</b>		$\alpha_{max}$				
	5490... 5895	MHz	—	1.8	2.5	dB
<b>Insertion attenuation – WLAN</b>		$\alpha_{WLAN}^{1)}$				
	5490... 5895	MHz	—	1.5	2.0	dB
<b>Amplitude ripple (p-p)</b>		$\Delta\alpha$				
	5490... 5895	MHz	—	0.7	1.5	dB
<b>Maximum VSWR</b>		$VSWR_{max}$				
@ input port	5490... 5895	MHz	—	1.6	2.2	
@ output port	5490... 5895	MHz	—	1.6	2.2	
<b>Attenuation</b>		$\alpha_{WLAN}^{1)}$				
	6105... 6265	MHz	8	31	—	dB
	6265... 7125	MHz	25	35	—	dB
<b>Minimum attenuation</b>		$\alpha_{min}$				
	30... 2000	MHz	32	36	—	dB
	2000... 2400	MHz	30	35	—	dB
	2400... 2500	MHz	30	34	—	dB
	2500... 3000	MHz	15	23	—	dB
	3400... 3800	MHz	28	32	—	dB
	3800... 4900	MHz	28	32	—	dB
	5170... 5330	MHz	46	50	—	dB
	7200... 7500	MHz	30	33	—	dB
	10980... 11790	MHz	—	37	—	dB

<sup>1)</sup> Average over each WLAN channel with band width of 160 MHz.

## 7 Maximum ratings

Operable temperature	$T_{OP} = -40\text{ °C} \dots +95\text{ °C}$	
Storage temperature	$T_{STG}^{1)} = -40\text{ °C} \dots +95\text{ °C}$	
DC voltage	$ V_{DC} ^{2)} = 0\text{ V (max.)}$	
ESD voltage		
	$V_{ESD}^{3)} = 325\text{ V (max.)}$	Human body model.
	$V_{ESD}^{4)} = 125\text{ V (max.)}$	Machine model.
Input power	$P_{IN}$	
@ input port: 5490 ... 5895 MHz	28 dBm	ON-state power of 160 MHz Wi-Fi downlink signal with 70% duty cycle for 27000 h @ 55 °C. Source and load impedance 50 Ω. <sup>5)</sup>
@ input port: other frequency ranges	10 dBm	Continuous wave for 10000 h @ 55 °C. Source and load impedance 50 Ω.

<sup>1)</sup> Not valid for packaging material. Storage temperature for packaging material is -25 °C to +40 °C.

<sup>2)</sup> In case of applied DC voltage blocking capacitors are mandatory.

<sup>3)</sup> According to JESD22-A114F (HBM – Human Body Model), 1 negative & 1 positive pulse.

<sup>4)</sup> According to JESD22-A115B (MM – Machine Model), 10 negative & 10 positive pulses.

<sup>5)</sup> Expected lifetime according to accelerated power durability tests and wear out models.

8 Transmission coefficient

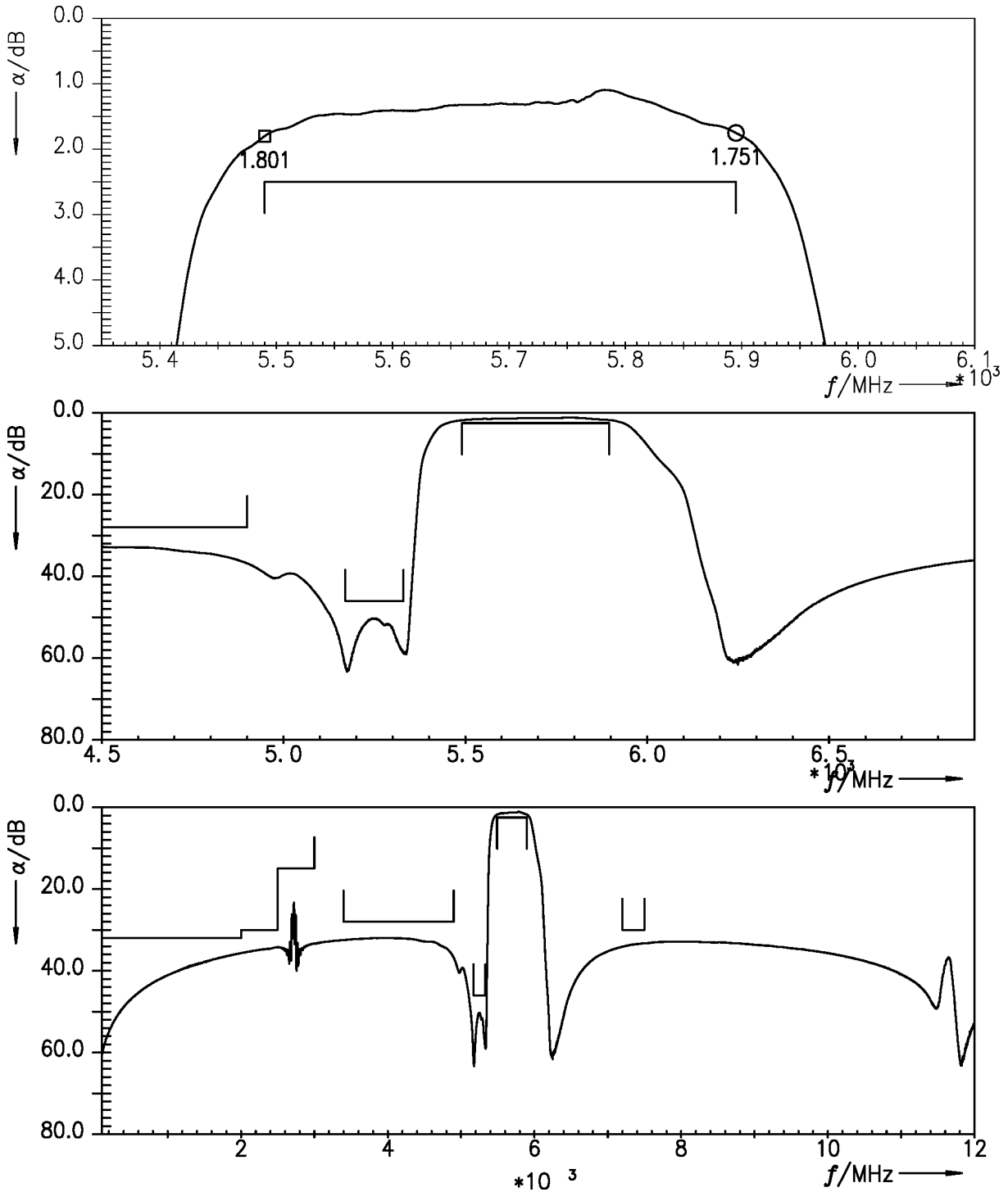


Figure 4: Attenuation.

9 Transmission coefficient (WLAN)

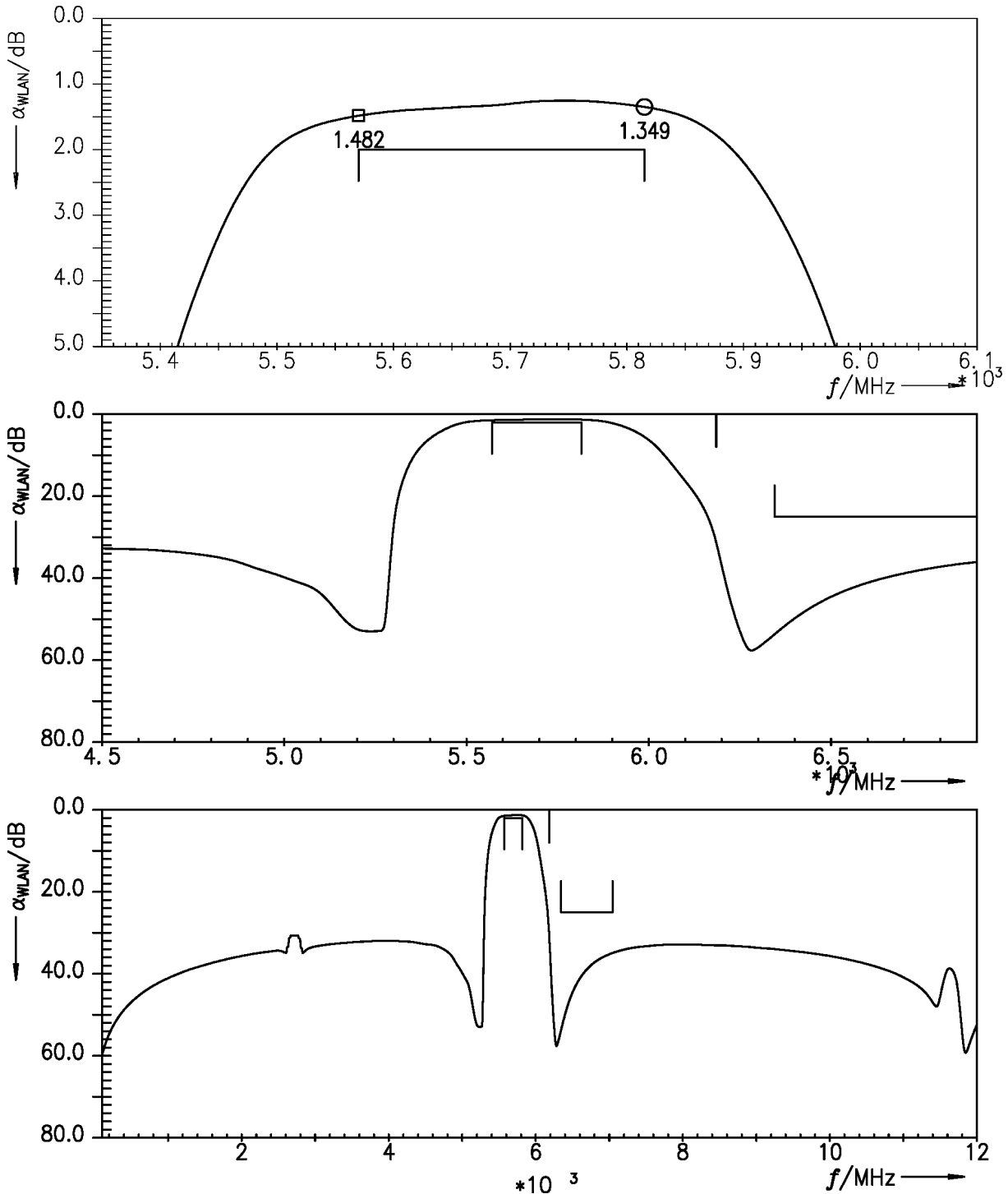


Figure 5: Attenuation (WLAN) (integration window = 160 MHz).

10 Reflection coefficients

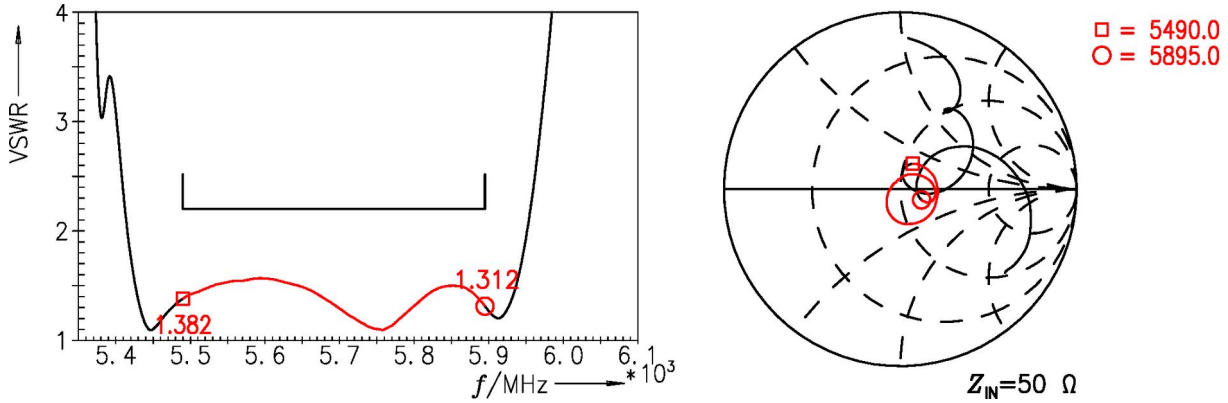


Figure 6: Reflection coefficient at input port.

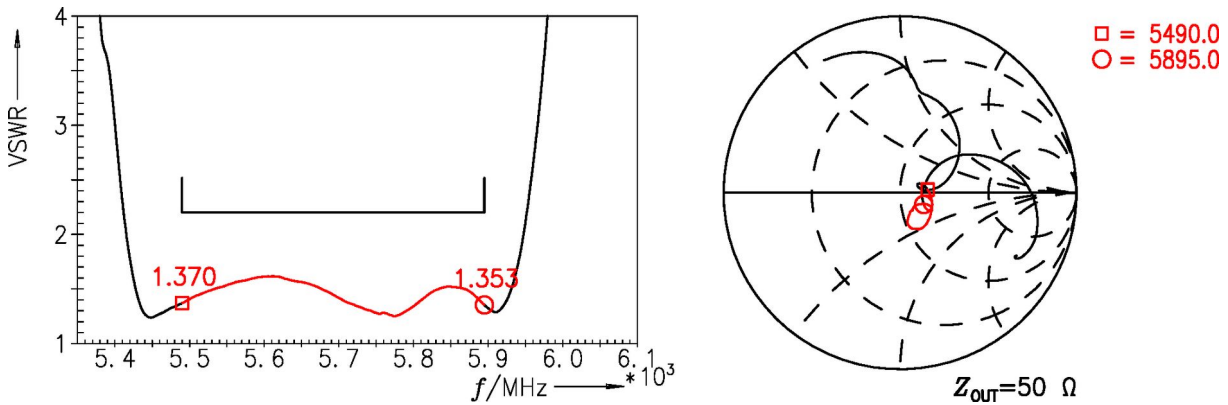
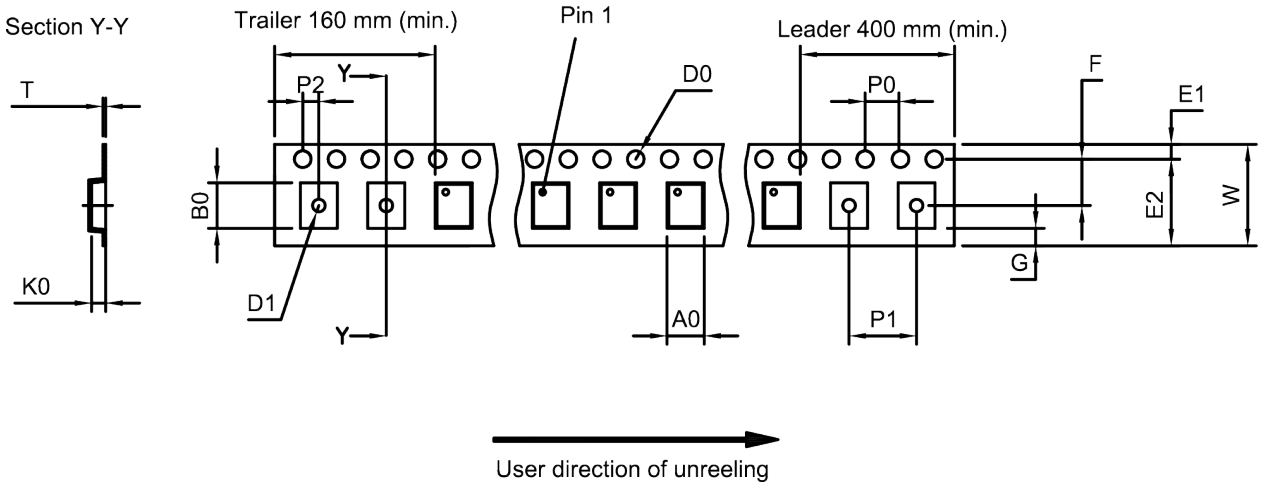


Figure 7: Reflection coefficient at output port.

11 Packing material

11.1 Tape



**Figure 8:** Drawing of tape (first-angle projection) for illustration only and not to scale. The valid tape dimensions are listed in Table 1.

A <sub>0</sub>	1.25±0.05 mm	E <sub>2</sub>	6.25 mm (min.)	P <sub>1</sub>	4.0±0.1 mm
B <sub>0</sub>	1.55±0.05 mm	F	3.5±0.05 mm	P <sub>2</sub>	2.0±0.05 mm
D <sub>0</sub>	1.5+0.1/-0 mm	G	0.75 mm (min.)	T	0.25±0.03 mm
D <sub>1</sub>	0.5±0.05 mm	K <sub>0</sub>	0.71±0.04 mm	W	8.0+0.3/-0.1 mm
E <sub>1</sub>	1.75±0.1 mm	P <sub>0</sub>	4.0±0.1 mm		

**Table 1:** Tape dimensions.

11.2 Reel with diameter of 180 mm

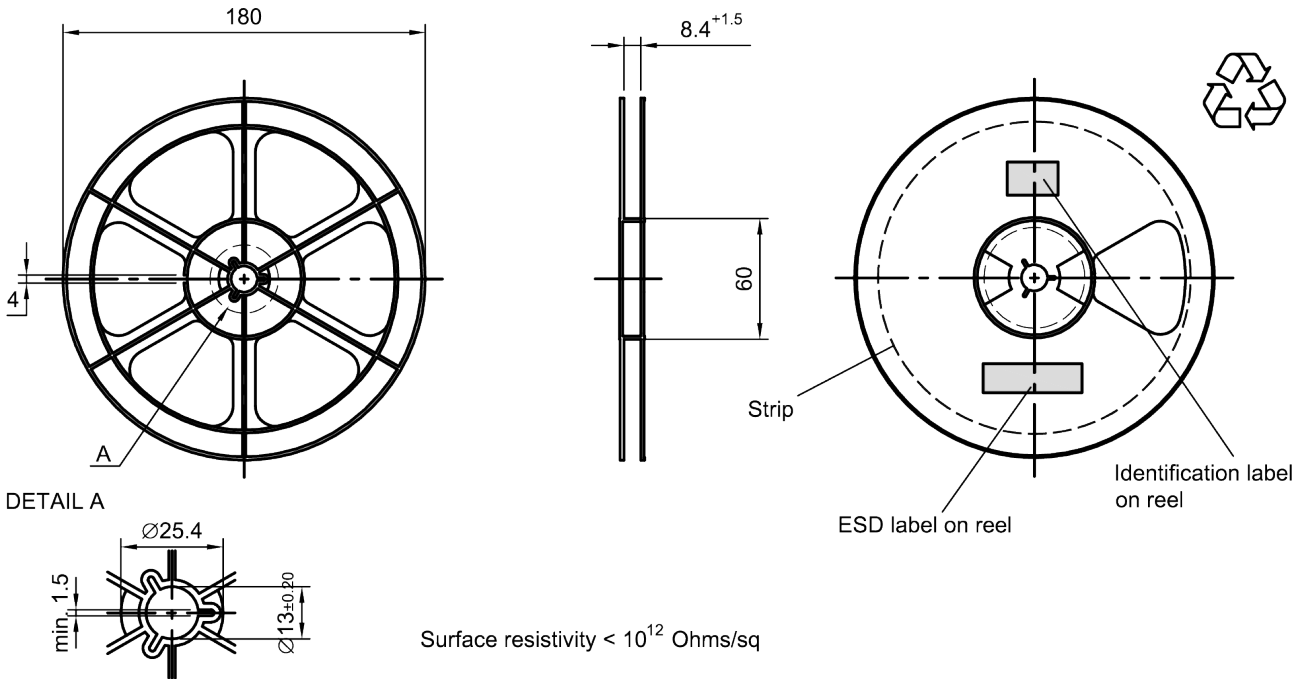


Figure 9: Drawing of reel (first-angle projection) with diameter of 180 mm.

Dimensions [mm]

X = 220+5

Y = 235+5

Sealing area 10±3

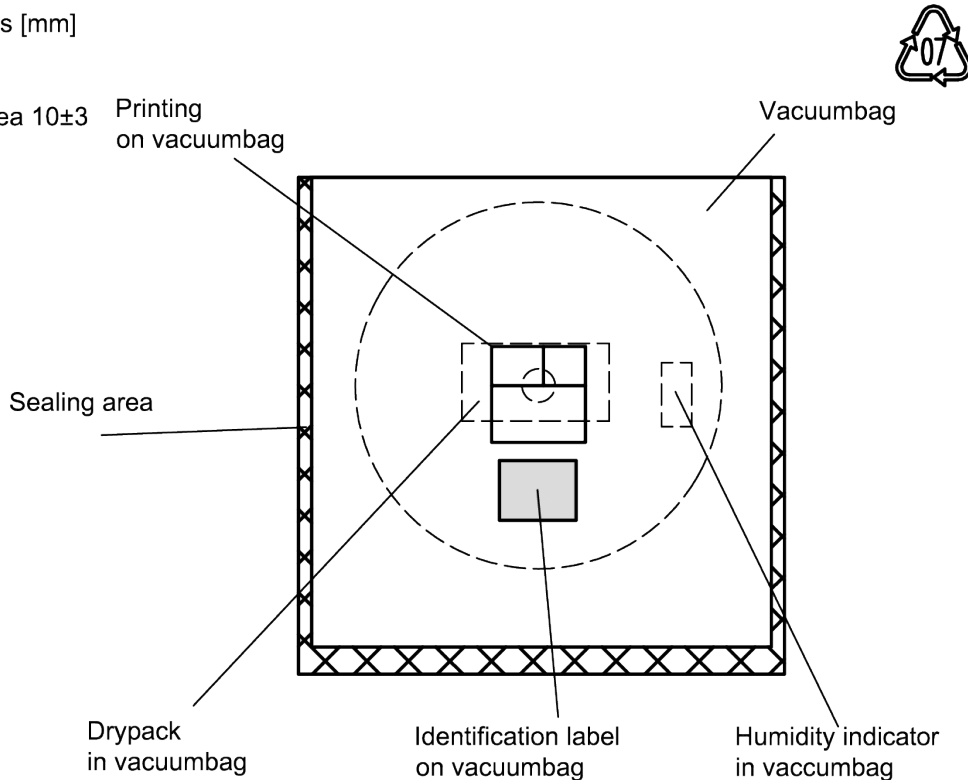
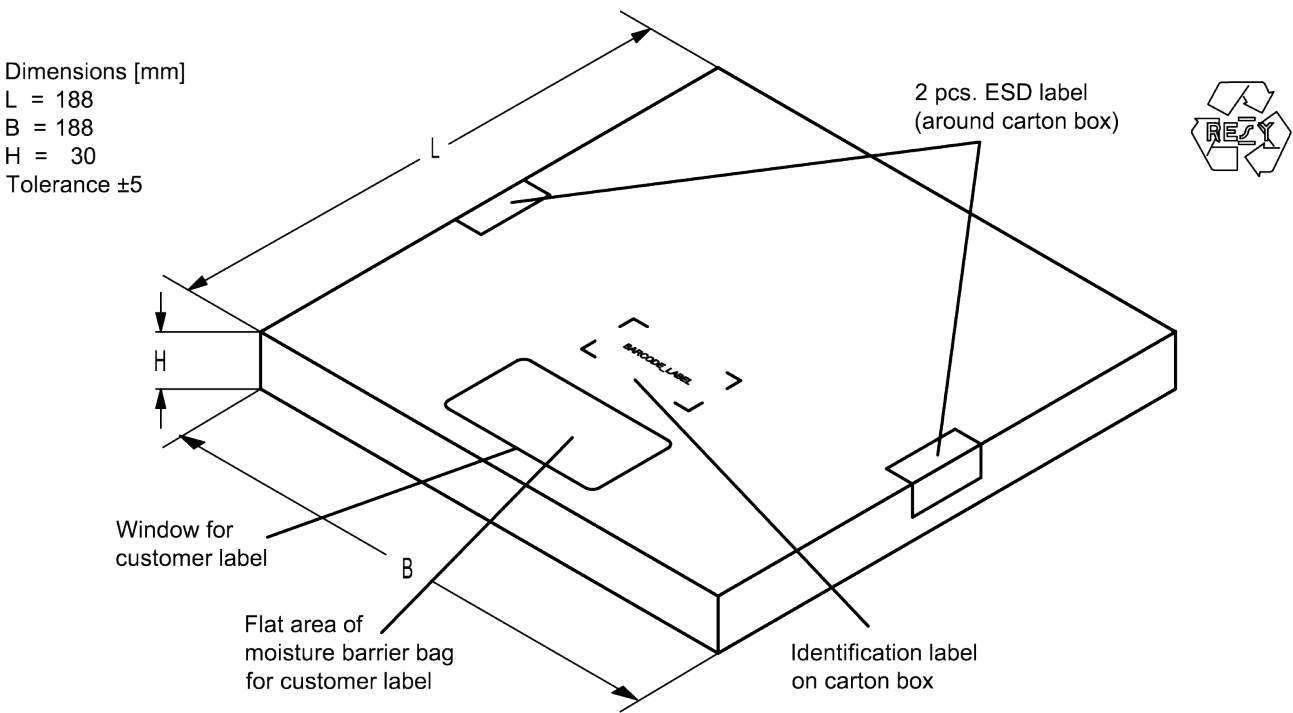


Figure 10: Drawing of moisture barrier bag (MBB) for reel with diameter of 180 mm.



**Figure 11:** Drawing of folding box for reel with diameter of 180 mm.

## 12 Marking

Products are marked with product type number and lot number encoded according to Table 2:

### ■ Type number:

The 4 digit type number of the ordering code, e.g., B3xxxxB**1234**xxxx,  
is encoded by a special BASE32 code into a 3 digit marking.

Example of decoding type number marking on device in decimal code.  
**16J** => **1234**  
 $1 \times 32^2 + 6 \times 32^1 + 18 (=J) \times 32^0 =$  **1234**  
 The BASE32 code for product type B8378 is 85T.

### ■ Lot number:

The last 5 digits of the lot number, e.g., **12345**,  
are encoded based on a special BASE47 code into a 3 digit marking.

Example of decoding lot number marking on device in decimal code.  
**5UY** => **12345**  
 $5 \times 47^2 + 27 (=U) \times 47^1 + 31 (=Y) \times 47^0 =$  **12345**

Adopted BASE32 code for type number			
Decimal value	Base32 code	Decimal value	Base32 code
0	0	16	G
1	1	17	H
2	2	18	J
3	3	19	K
4	4	20	M
5	5	21	N
6	6	22	P
7	7	23	Q
8	8	24	R
9	9	25	S
10	A	26	T
11	B	27	V
12	C	28	W
13	D	29	X
14	E	30	Y
15	F	31	Z

Adopted BASE47 code for lot number			
Decimal value	Base47 code	Decimal value	Base47 code
0	0	24	R
1	1	25	S
2	2	26	T
3	3	27	U
4	4	28	V
5	5	29	W
6	6	30	X
7	7	31	Y
8	8	32	Z
9	9	33	b
10	A	34	d
11	B	35	f
12	C	36	h
13	D	37	n
14	E	38	r
15	F	39	t
16	G	40	v
17	H	41	\
18	J	42	?
19	K	43	{
20	L	44	}
21	M	45	<
22	N	46	>
23	P		

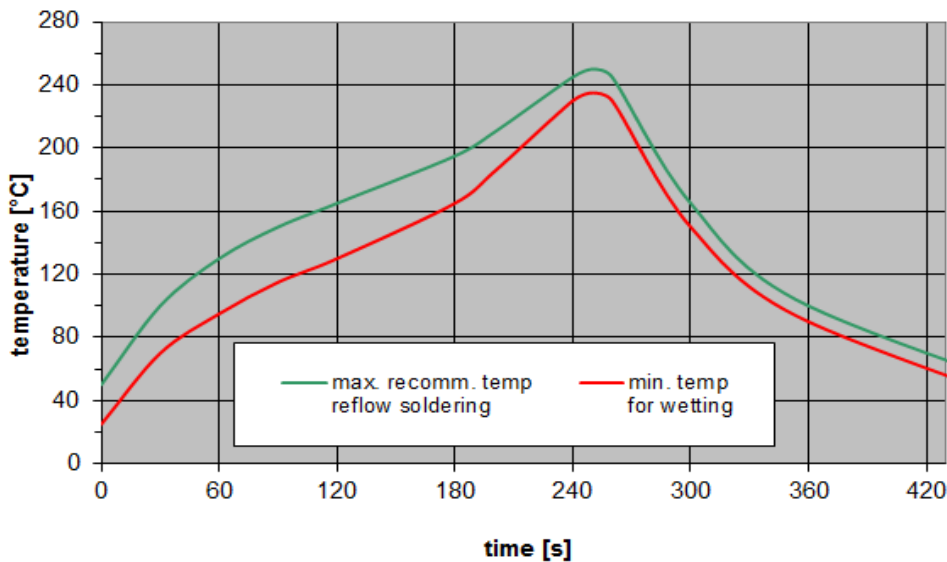
**Table 2:** Lists for encoding and decoding of marking.

### 13 Soldering profile

The recommended soldering process is in accordance with IEC 60068-2-58 – 3<sup>rd</sup> edit and IPC/JEDEC J-STD-020B.

ramp rate	≤ 3 K/s
preheat	125 °C to 220 °C, 150 s to 210 s, 0.4 K/s to 1.0 K/s
$T > 220\text{ °C}$	30 s to 70 s
$T > 230\text{ °C}$	min. 10 s
$T > 245\text{ °C}$	max. 20 s
$T \geq 255\text{ °C}$	–
peak temperature $T_{\text{peak}}$	250 °C +0/-5 °C
wetting temperature $T_{\text{min}}$	230 °C +5/-0 °C for 10 s ± 1 s
cooling rate	≤ 3 K/s
soldering temperature $T$	measured at solder pads

**Table 3:** Characteristics of recommended soldering profile for lead-free solder (Sn95.5Ag3.8Cu0.7).



**Figure 12:** Recommended reflow profile for convection and infrared soldering – lead-free solder.

## 14 Annotations

### 14.1 RoHS compatibility

ROHS-compatible means that products are compatible with the requirements according to Art. 4 (substance restrictions) of Directive 2011/65/EU of the European Parliament and of the Council of June 8th, 2011, on the restriction of the use of certain hazardous substances in electrical and electronic equipment ("Directive") with due regard to the application of exemptions as per Annex III of the Directive in certain cases.

### 14.2 Scattering parameters (S-parameters)

The pin/port assignment is available in the headers of the S-parameter files. Please contact your local RF360 sales office.

### 14.3 Ordering codes, product IDs, labels, and packing units

Ordering code	Product ID	RF360 label	Packing unit
B39572B8378L210	B39572-B8378-L210-W05	B39572B8378L210W 5	5000 pcs

**Table 4:** Ordering codes / product IDs and packing units.

## 15 Cautions and warnings

### 15.1 Display of ordering codes for RF360 products

The ordering code for one and the same product can be represented differently in data sheets, data books, other publications and the website of RF360, or in order-related documents such as shipping notes, order confirmations and product labels. The varying representations of the ordering codes are due to different processes employed and do not affect the specifications of the respective products. Detailed information can be found on the Internet under <https://rfe.qualcomm.com/>.

### 15.2 Material information

Due to technical requirements components may contain dangerous substances. For information on the type in question please also contact one of our sales offices.

For information on recycling of tapes and reels please contact one of our sales offices.

### 15.3 Moldability

Before using in overmolding environment, please contact your local RF360 sales office.

### 15.4 Package information

#### Landing area

The printed circuit board (PCB) land pattern (landing area) shown is based on RF360 internal development and empirical data and illustrated for example purposes, only. As customers' SMD assembly processes may have a plenty of variants and influence factors which are not under control or knowledge of RF360, additional careful process development on customer side is necessary and strongly recommended in order to achieve best soldering results tailored to the particular customer needs.

#### Dimensions

Unless otherwise specified all dimensions are understood using unit millimeter (mm).

#### Projection method

Unless otherwise specified first-angle projection is applied.

## 16 ESD protection of acoustic devices

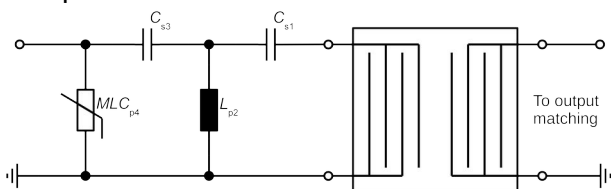
Acoustic devices are **Electro Static Discharge** sensitive devices. To reduce the probability of damages caused by ESD, special matching topologies must be applied.

In general, “ESD matching” must be ensured at that electrical port, where electrostatic discharge is expected.

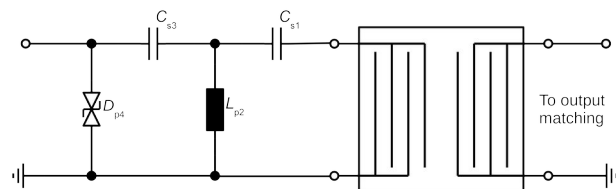
Electrostatic discharges predominantly appear at the antenna input of RF receivers. Therefore, only the input matching of the acoustic device must be designed to short circuit or to block the ESD pulse.

Below three figures show recommended “ESD matching” topologies.

For wide band acoustic devices the high-pass ESD matching structure needs to be at least of 3<sup>rd</sup> order to ensure a proper matching for any impedance value of antenna and input port. The required component values must be determined from case to case.

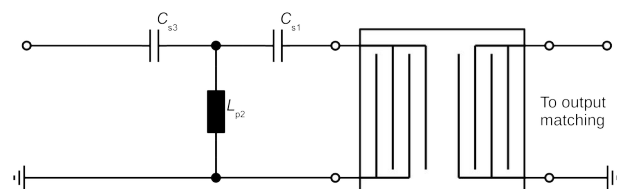


**Figure 13:** MLC varistor plus ESD matching.



**Figure 14:** Suppressor diode plus ESD matching.

In cases where minor ESD occur, following simplified “ESD matching” topologies can be used alternatively.



**Figure 15:** 3<sup>rd</sup> order high-pass structure for basic ESD protection.

In all three figures the shunt inductor  $L_{p2}$  could be replaced by a shorted microstrip with proper length and width. If this configuration is possible depends on the operating frequency and available PCB space.

Effectiveness of the applied ESD protection has to be checked according to relevant industry standards or customer specific requirements.

For further information, please refer to RF360 Application report: “**ESD protection for SAW filters**”. This report can be found under <https://rfe.qualcomm.com>.

## 17 Important notes

The following applies to all products named in this publication:

1. Some parts of this publication contain **statements about the suitability of our products for certain areas of application**. These statements are based on our knowledge of typical requirements that are often placed on our products in the areas of application concerned. We nevertheless expressly point out **that such statements cannot be regarded as binding statements about the suitability of our products for a particular customer application**. As a rule, RF360 Europe GmbH and its affiliates are either unfamiliar with individual customer applications or less familiar with them than the customers themselves. For these reasons, it is always ultimately incumbent on the customer to check and decide whether an RF360 product with the properties described in the product specification is suitable for use in a particular customer application.
2. We also point out that **in individual cases, a malfunction of electronic components or failure before the end of their usual service life cannot be completely ruled out in the current state of the art, even if they are operated as specified**. In customer applications requiring a very high level of operational safety and especially in customer applications in which the malfunction or failure of an electronic component could endanger human life or health (e.g. in accident prevention or life-saving systems), it must therefore be ensured by means of suitable design of the customer application or other action taken by the customer (e.g. installation of protective circuitry or redundancy) that no injury or damage is sustained by third parties in the event of malfunction or failure of an electronic component.
3. **The warnings, cautions and product-specific notes must be observed.**
4. In order to satisfy certain technical requirements, **some of the products described in this publication may contain substances subject to restrictions in certain jurisdictions (e.g. because they are classed as hazardous)**. Useful information on this will be found in our Material Data Sheets on the Internet (<https://rfe.qualcomm.com>). Should you have any more detailed questions, please contact our sales offices.
5. We constantly strive to improve our products. Consequently, **the products described in this publication may change from time to time**. The same is true of the corresponding product specifications. Please check therefore to what extent product descriptions and specifications contained in this publication are still applicable before or when you place an order. We also **reserve the right to discontinue production and delivery of products**. Consequently, we cannot guarantee that all products named in this publication will always be available.  
The aforementioned does not apply in the case of individual agreements deviating from the foregoing for customer-specific products.